



The Name Solar Lighting International® is a Registered Trademark.

Phone +1 803 233 3461

# STEALTH II

## 80-23

### LED Solar Street Light



Solar Lighting International® is a Registered Trademark.



## Welcome

Solar Lighting International®, Inc. was started in 2006 after being split off from SC Solar, Inc. to bring custom-engineered solar lighting and traffic management applications to the forefront of much-needed infrastructure upgrades in the U.S. and worldwide.

Solar Lighting International, Inc. is an industry-leading designer and manufacturer of superior commercial solar lighting products. We have been manufacturing solar lighting systems since 2004 when the X-35 series commercial solar light was released. We have expanded since then and offer a wide range of solar LED street and parking lot lighting systems, pathway lighting, solar light poles, solar traffic and safety products, solar railroad crossings and custom lighting applications. Our products are designed and engineered in the United States and are a symbol of high-quality solar lighting solutions.

All of our solar LED light solutions are versatile and can be ground or pole-mounted for any size project. These systems also come backed by a comprehensive 5-year warranty\*.

Solar Lighting International has a variety of selected installing partners and distributors in the U.S., U.S. Virgin Islands, Bahamas, Puerto Rico, Turks & Caicos, Trinidad & Tobago, Oman, Saudi Arabia, Suriname, El Salvador, Ecuador, and Bahrain.

With a diverse group of contractors and partners, SLI has a global engineering and sales workforce experienced in project analysis and implementation. Providing superior customer service, Solar Lighting International is blessed to have many loyal and repeat customers.

We hope you will join our vision and become part of the SLI family.





Solar Lighting International® is a Registered Trademark.



## Features & Advantages

- ◆ Replaceable Parts - Replaceable Battery | Replaceable Light Bar.
- ◆ Remote control makes changing the work modes effortless.
- ◆ Multiple light distribution optic lenses provides a variety of options.
- ◆ High Quality Mono-crystalline Solar Panel & MPPT Charge Controller.
- ◆ LED light bars are adjustable to 50°.
- ◆ Wide angle detection enables body movement in a larger area and a longer distance.
- ◆ IoT - Central utility managed control via computer.
- ◆ IoT Technology can integrate with current AC lighting infrastructure for a centralized lighting management solution.
- ◆ Long life Lithium Iron Phosphate battery: LiFePO4.

Solar Lighting International® is a Registered Trademark.



## Hassle-free Battery & Controller Replacement Design

Our solar street lights feature a user-friendly battery and controller system, allowing swift and seamless replacements when needed. No more extensive technical knowledge required - just simple plug-and-play functionality.

The convenience and efficiency with our easy replacement design ensures your solar street lights stay operational, minimize disruptions, and maximize their lifespan.

Solar Lighting International® is a Registered Trademark.



## Specifications

Product Model	STEALTH II 40W-23	STEALTH II 80W-23	STEALTH II 120W-23	STEALTH II 120W-23-O
Power	40W	80W	120W	120W
Lumen / LED Type	7,400 Lumens (Phillips 5050)	14,800 Lumens (Phillips 5050)	22,200 Lumens (Phillips 5050)	22,200 Lumens (Phillips 5050)
Color Temperature	4000K ± 300K	4000K ± 300K	4000K ± 300K	4000K ± 300K
BUG Rating	B1-U0-G2	B1-U0-G2	B1-U0-G2	B1-U0-G2
Battery	LiFePO <sub>4</sub> 24AH, 12.8V / 307.2Wh	LiFePO <sub>4</sub> 48AH, 12.8V / 614.4Wh	LiFePO <sub>4</sub> 36AH, 25.6V / 921.6Wh	LiFePO <sub>4</sub> 48AH, 25.6V / 1228.8Wh
Solar Panel	Mono-crystalline   48 Watt	Mono-crystalline   65 Watt	Mono-crystalline   100 Watt	Mono-crystalline   100 Watt
Light Dimensions	34.1"×16.2"×3.94" 866×411×277mm	45.9"×16.2"×3.94" 1166×411×277mm	65.6"×16.2"×3.94" 1166×411×277mm	65.6"×16.2"×3.94" 1166×411×277mm
Working Time	Up to 14 Hrs if fully charged, Alternate working modes and working times, ranges from 3 - 6 nights.			Up to 16 Hrs if fully charged, Alternate working modes and working times, ranges from 3 - 6 nights.
Charging Time	Requires 6 hours of direct sunlight at optimal angle. Optimal direction is magnetic south and the optimal angle equals the latitude of the installation. Performance is reduced if product is installed different than the optimal angle or non-South facing.			
Beam Angle	Standard Distribution: 150 x 75° - Type III or Bat-Wing Style   Optional Lens Distribution for Type I, Type II & Type V *			
PIR Sensor	2 PIR Sensors   Detection angle: 150°   Detection distance: up to 5 Meters / 50 Feet			
IP Class	IP66			
Working Temp	-10°F - 140°F / -23C° - 60C°			
Housing Material	Powder Coated Aluminum   Salt Spray Coating			
Weight N.W./G.W.	41 lbs.   49 lbs. 18 kg   22 kg	57 lbs.   71 lbs. 26 kg   32 kg	71 lbs.   84 lbs. 32 kg   38 kg	86 lbs.   102 lbs. 39 kg   47 kg
Box Dimensions	43.9"×19.5"×7.1" 1115×495×180mm	55.7"×19.5"×7.1" 1415×495×180mm	75.4"×19.5"×7.1" 1915×495×180mm	75.4"×19.5"×7.1" 1915×495×180mm
Installation Height	10' - 15' or 3-5m	15' - 25' or 5 - 8m	20' - 30' or 6 - 9m	20' - 30' or 6 - 9m
Installation Spacing	32' - 50' or 10-15m	50' - 82' or 15 - 25m	100' - 150' or 30 - 50m	100' - 150' or 30 - 50m
EPA	2	4	6	6
Warranty	5 years **			

\* Default lens is Type III, other options available.

\*\* Prorated if not installed per optimal instructions.



Solar Lighting International® is a Registered Trademark.



## Photometrics

60×100° (TYPE I -VS)

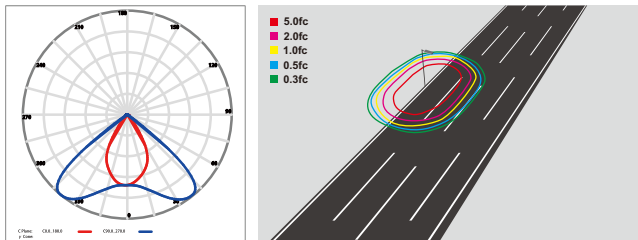

70×135° (TYPE II -S)

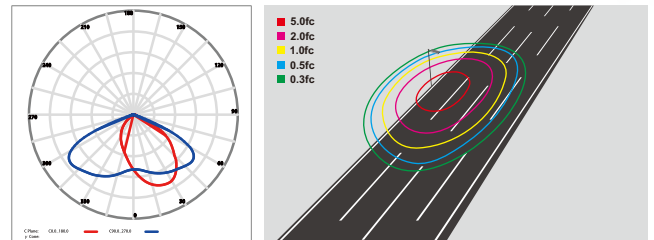

75×150° (TYPE III -M)

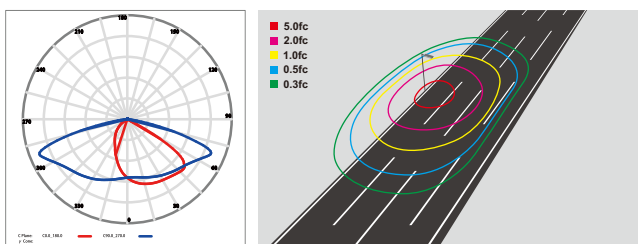

80×150° (TYPE III -S)

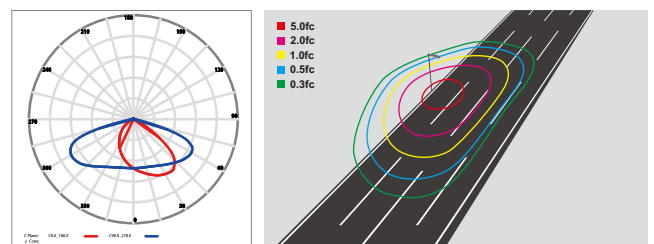

150° (TYPE VS)

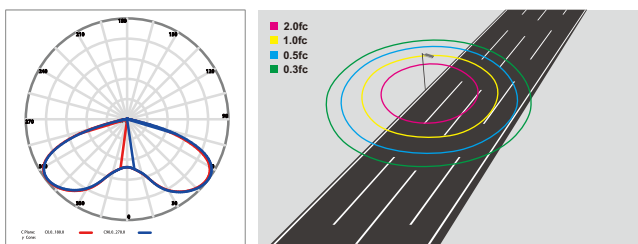

- \* Type III default light distribution.
- \* All lens options available at additional cost, must specify at time of order.
- \* Fixture Mounting at 20Feet. Fixture tested at full power.

Solar Lighting International® is a Registered Trademark.

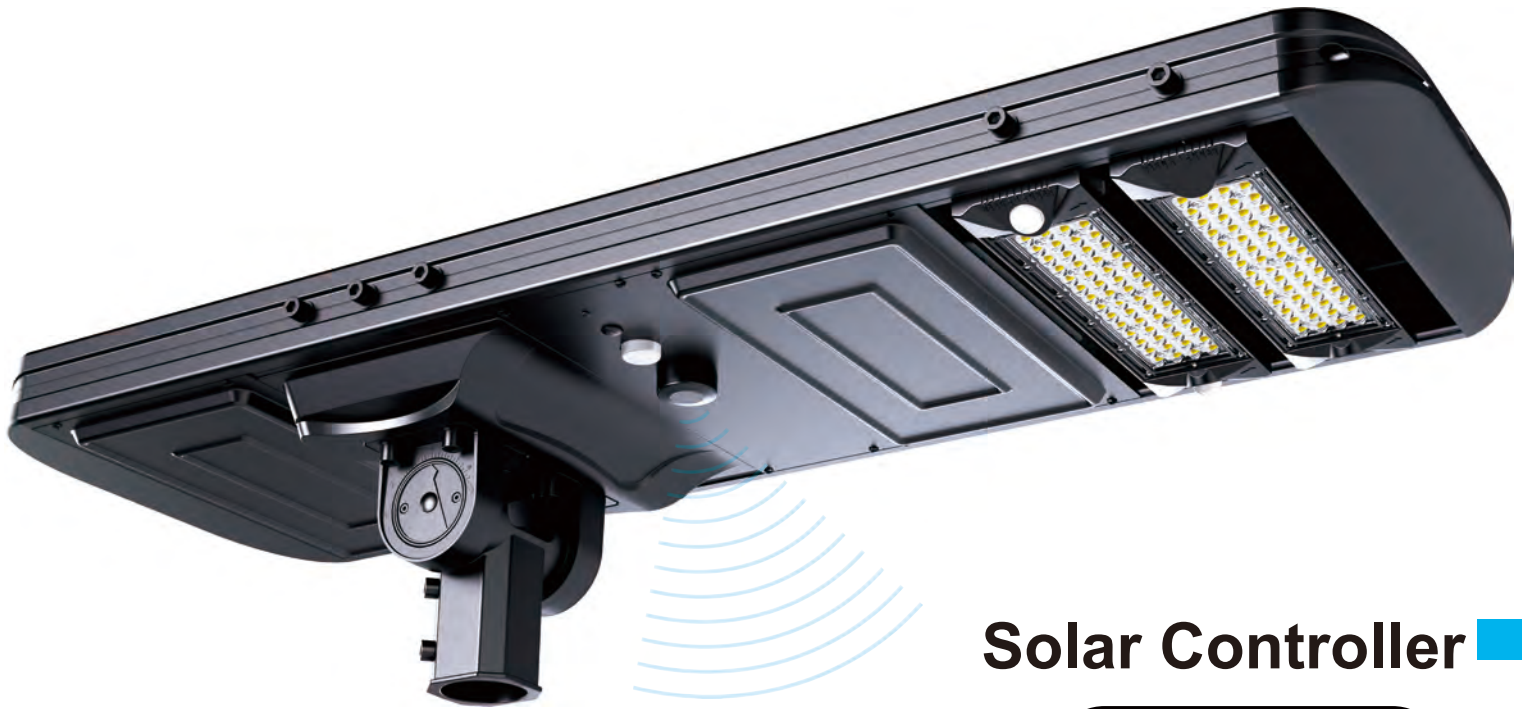



## Solar Controller



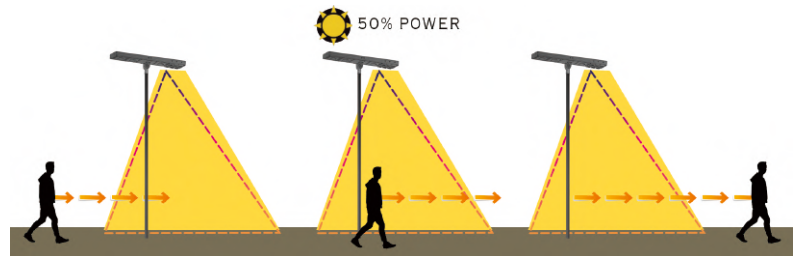

 **Power Button**

 **Constant Lighting Mode**  
Automatically operates at 50% brightness from dusk to dawn or until power is off.

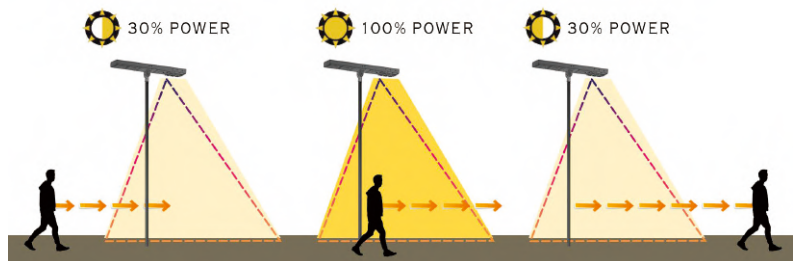

 **Sensor Mode**  
Automatically operates at 30% brightness. When motion is detected, light increases to 100% until no motion is detected for 30 seconds, then returns to 30% brightness. Detection up to 50 feet.



 **Customized Working Mode**  
Automatically turns on at dusk and remains at up to 100% brightness for 4 hours, then it automatically turns to 30% brightness until dawn.

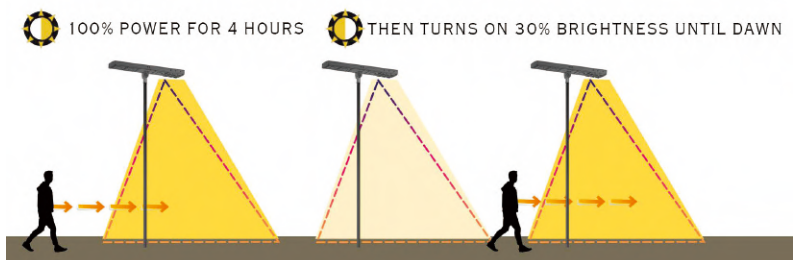

Solar Lighting International® is a Registered Trademark.

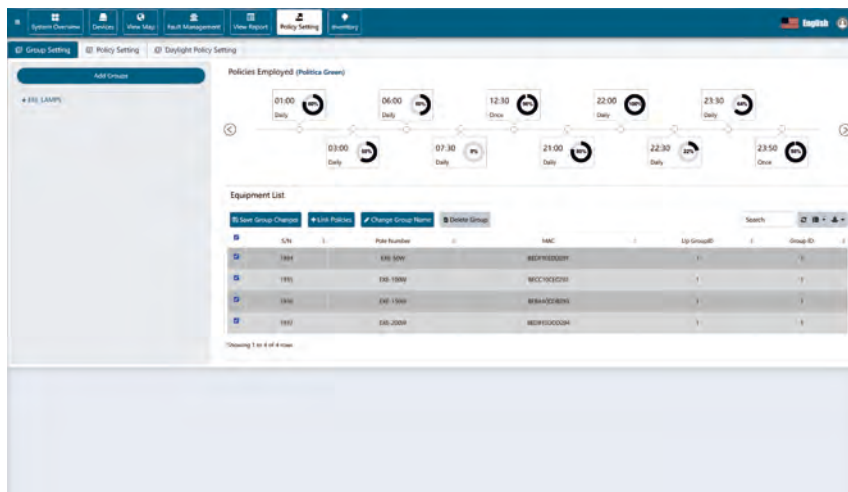
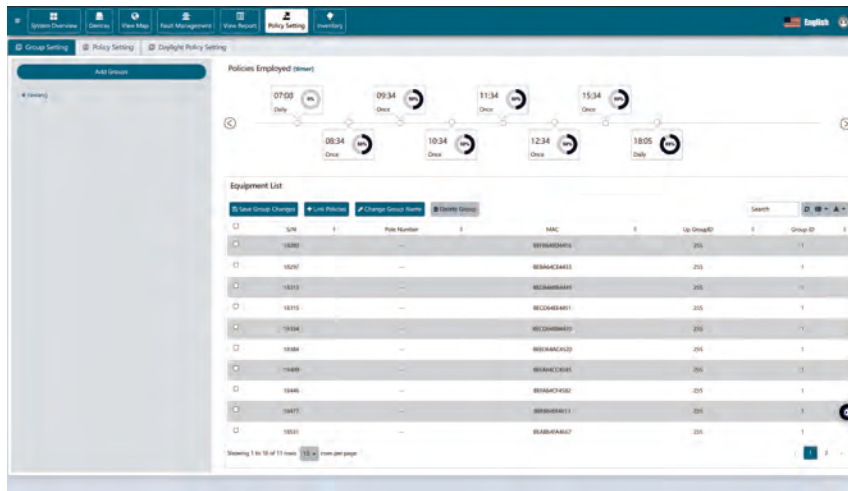

## IOT Integrated Solar Controller

Seamlessly integrated with our cutting-edge IoT-based smart lighting control technology, this controller provides all functions of our standard solar controller while harnessing the power of connectivity to remotely manage and optimize your solar street lights. Enjoy real-time monitoring, adaptive brightness control, and scheduling capabilities, all at your fingertips. With seamless integration into our solar street lights, you can achieve enhanced energy savings, reduced maintenance costs, and a greener footprint.

Embrace smart technology for a brighter and smarter tomorrow with our IoT-based smart solar lighting control system.



Solar Lighting International® is a Registered Trademark.

# SLiNET Smart Control System

## Smart City

- Smart project control perfectly combines the solar street lighting fixture, internet of things, with wireless communication technology, to achieve seamless monitoring and management of any project. Providing remote background data, real-time understanding of the working status of each system component (street lights, photovoltaic panels, batteries, controllers). This allows you to know the system usage from the client terminal, possibly thousands of miles away without leaving home or the office. The ability to manage the operation and maintenance of your lighting project is unparalleled.

- The solar street light management system can pre-set one or more lighting modes according to the different time of day, adjust to traffic flow, automatically turn on or off any light, and adjust the switching time and illumination, according to environmental requirements. This allows your project to achieve the maximum energy-savings. We can even integrate your current AC electrical lighting fixtures into our platforms for mixed use control and monitoring.

- Solar Lighting International's IoT-integrated system is composed of the street light, 4G Gateway, a single light node controller, and our smart cloud platform. The centralized controller and the gateway controller transmits the data collected from each fixture via the wireless communication network and 4G. The centralized controller uploads data to a secure cloud platform through GPRS data flow, allowing data access for mobile phone and computer terminal access.

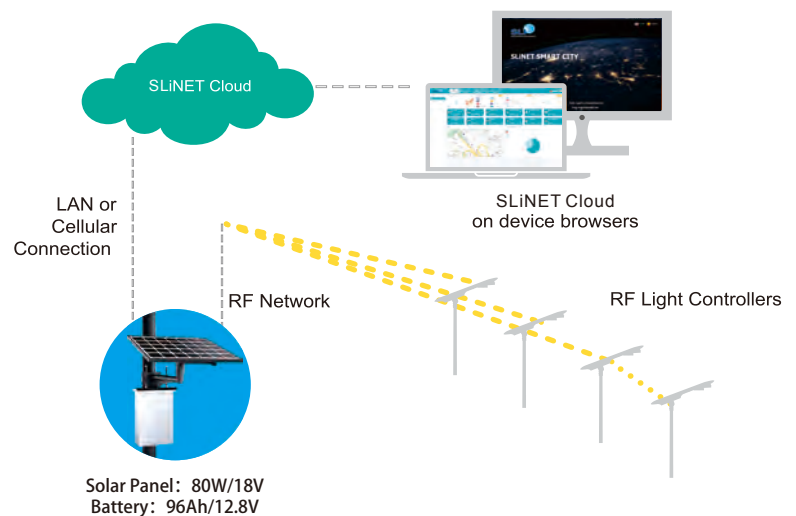
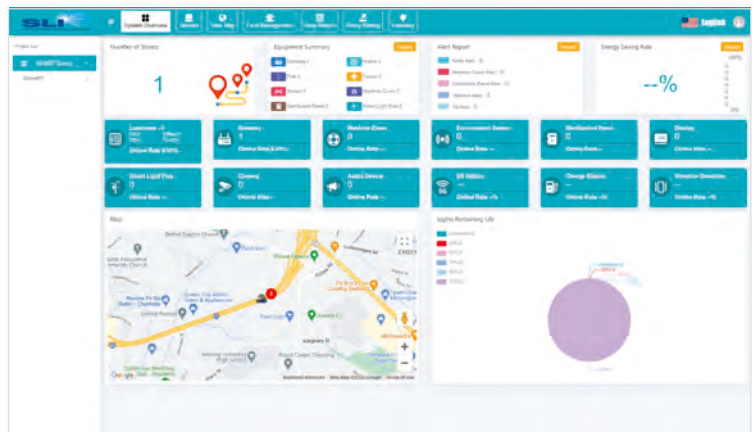
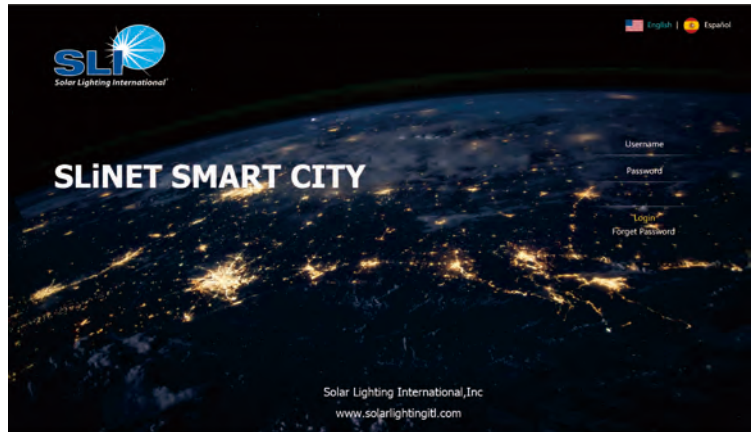

Solar Lighting International® is a Registered Trademark.

## Product Dimensions

**40W**

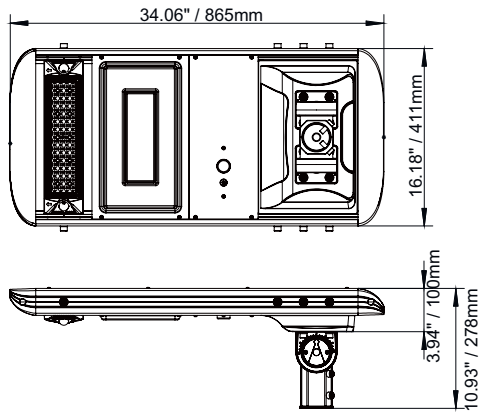

**80W**

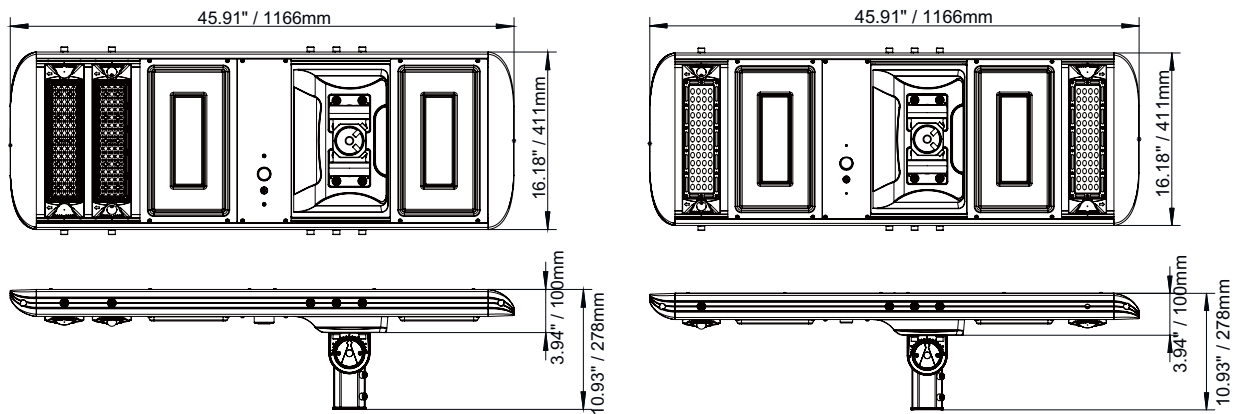

**120W**

